

Caratteristiche tecniche Technical descriptions

STRUTTURA: telaio in massello di legno e multistrato di abete. Il molleggio della seduta è realizzato con cinghie elastiche ad alta resistenza.

IMBOTTITURA: la struttura è imbottita con inserti sagomati in poliuretano espanso con densità differenziate ed infine ricoperta con una fodera in falda resinata accoppiata a maglina. I cuscini di seduta sono in piuma d'oca lavata e sterilizzata e fiocchi di fibra di poliestere suddivisi a scomparti con anima in poliuretano espanso densità 35 kg/m³. Lo schienale ed il bracciolo sono ricoperti superiormente con tela di cotone 100% che contiene piuma d'oca lavata e sterilizzata e fiocchi di fibra di poliestere suddivisi a scomparti.

RIVESTIMENTO: in tessuto o in pelle completamente sfoderabile.

PIEDINI: in metallo con finitura cromata h 6 cm.

CUCITURE: rivestimenti in tessuto cuciti con "filetto vuoto", standard in tinta o, a richiesta, con tinta diversa dello stesso tessuto; rivestimenti in pelle cuciti con "filetto vuoto".

NOTE: le misure sono espresse in centimetri.

FRAMEWORK: made of solid wood and plywood panels. The springing of the seat is provided by elastic webbing with high resistance.

PADDING: the frame is padded with variable densities and modeled polyurethane foam. The frame is then covered with a layer of clinging resin-treated polyester. Seat cushions are made of washed and sterilized goose down and polyester fibre divided into sections, with a polyurethane foam core, density 35 kg/ m³. The upper part of the back and the arm are covered with 100% cotton lining which contains washed and sterilized goose down and polyester fibre divided into sections.

COVER: fabric or leather linings are completely removable.

FEET: made of chromed metal h 6 cm.

STITCHINGS: fabric covers are stitched with "filetto vuoto" stitching, in the same color of the cover or, by request, in a different color of the same fabric; leather covers are stitched with a "filetto vuoto" stitching.

NOTES: measures are expressed in centimeters.

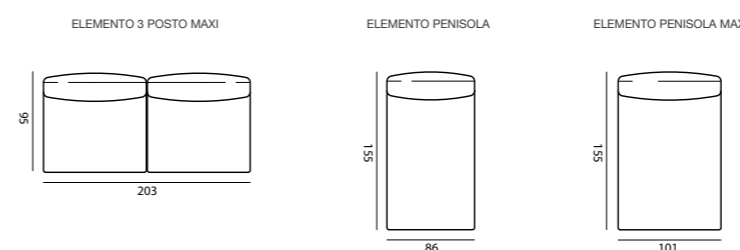
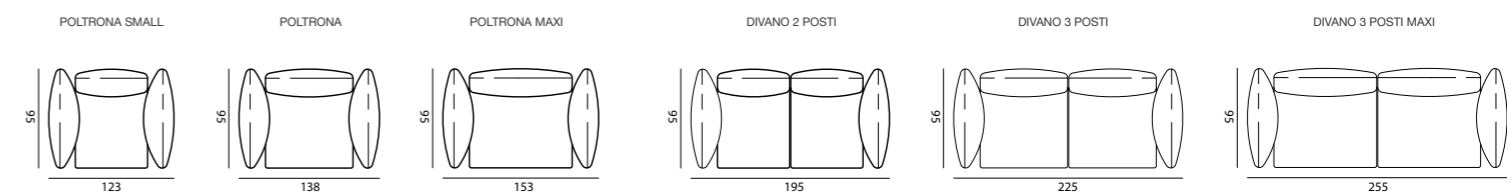
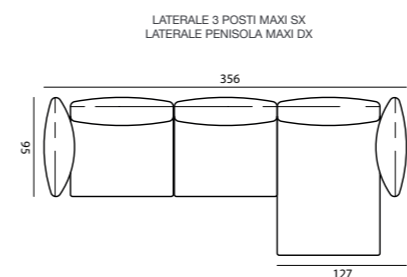
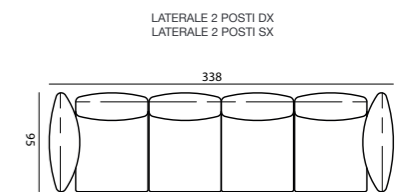
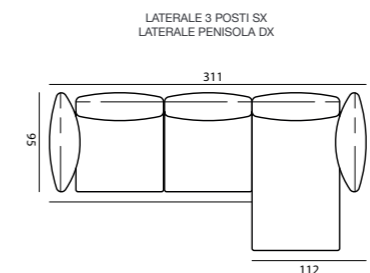
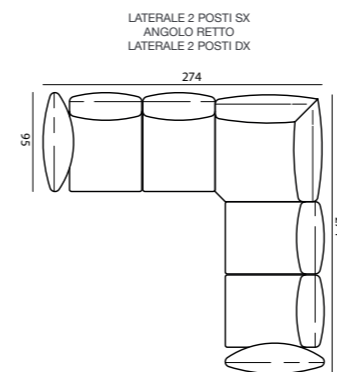
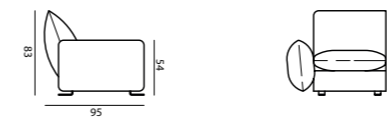

LATERALE 1 POSTO
SMALL DX/SX

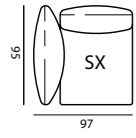

LATERALE 1 POSTO DX/SX

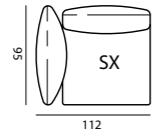

LATERALE 1 POSTO MAXI DX/SX

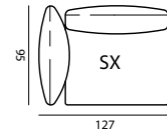

LATERALE 2 POSTI DX/SX

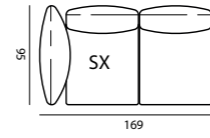

LATERALE 3 POSTI DX/SX

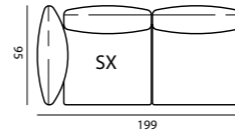

LATERALE 3 POSTI MAXI DX/SX

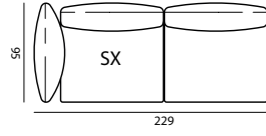

LATERALE PENISOLA DX/SX

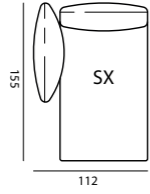

LATERALE PENISOLA MAXI DX/SX

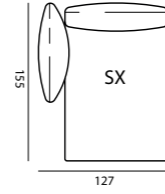

ANGOLO RETTO

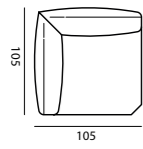

POUFF QUADRATO

